

- SuperATV does not recommend keeping Roof installed while transporting on an open air trailer. Remove or secure with straps.

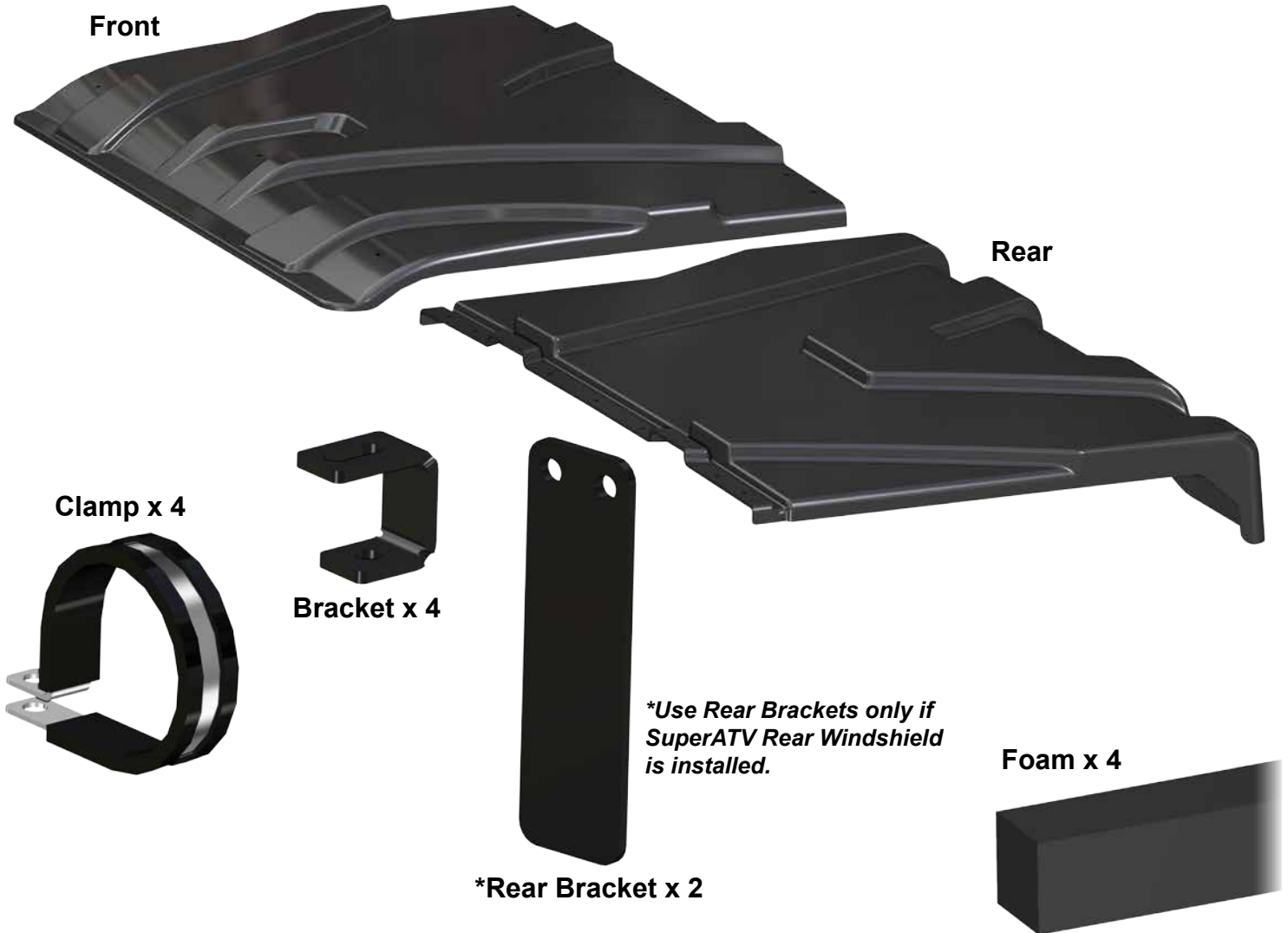

(Kit contents continue on following page)

- If Roofs appear warped, place in direct sunlight for an hour. Roofs will return to original molded shape.
- When installing, 2 people will be required at certain steps.
- Machine shown in illustrations has SuperATV Front and Rear Windshields installed; not included.

Need help with your installation?



sales@superatv.com



www.superatv.com



1-855-743-3427



8:00am - 8:00pm EST M-Th
 8:00am - 7:00pm EST Friday
 9:00am - 2:00pm EST Saturday

Read instructions and view illustrations before beginning.

Thank You
 For Choosing



(Kit contents continued)

Unless noted, do not tighten hardware completely when installing.

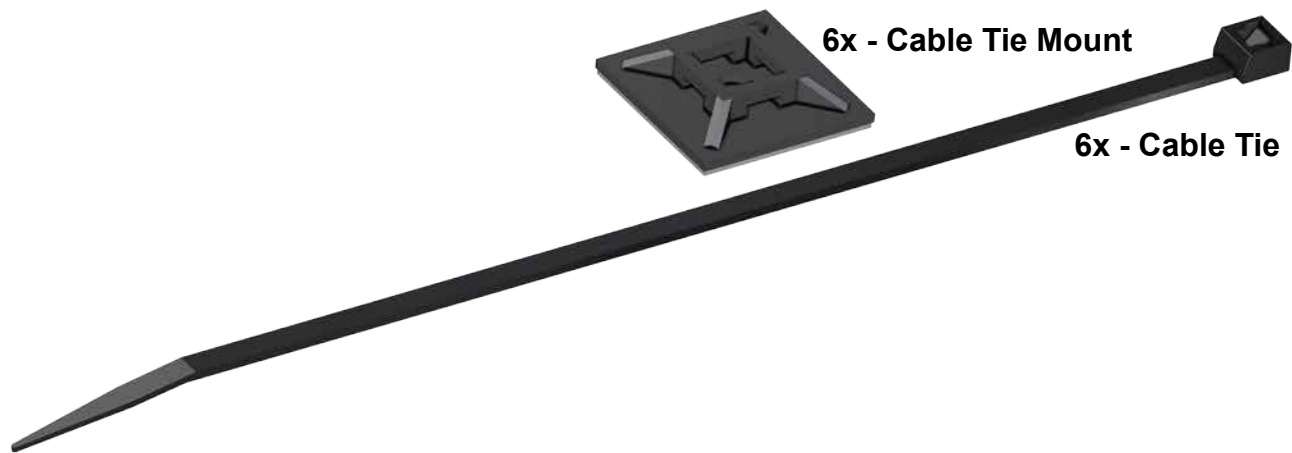

Liability Statement

SuperATV's® products are designed to best fit user's ATV/UTV under stock conditions. Adding, modifying, or fabricating any factory or aftermarket parts will void any warranty provided by SuperATV® and is not recommended. SuperATV's® products could interfere with other aftermarket accessories. If user has aftermarket products on machine, contact SuperATV® to verify that they will work together.

Although SuperATV® has thousands of satisfied customers, user should be aware that installing lift kits, long travel, or suspension kits, tires, etc. will change the ride of machine and may increase maintenance and part wear. Operating any off-road machine while, or after, consuming alcohol and/or drugs increases risk of bodily harm or death. No warranty or representation is made as to this product's ability to protect user from severe injury or death. SuperATV® urges operators and occupants to wear a helmet and appropriate riding gear at all times.

By purchasing and installing SuperATV® products, user agrees that should damages occur, SuperATV® will not be held responsible for loss of time, use, labor fees, replacement parts, or freight charges. SuperATV®, nor any 3rd party, will not be held responsible for any direct, indirect, incidental, special, or consequential damages that result from any product purchased from SuperATV®. The total liability of seller to user for all damages, losses, and causes of action, if any, shall not exceed the total purchase price paid for the product that gave rise to the claim.

SuperATV® will warranty only parts provided by SuperATV®. Any damage or problems with OEM housings, bearings, seals, or other manufacturers' products will not be covered by SuperATV®. SuperATV® parts and products are not warrantied if item was not installed properly, misused, or modified.

Installing, adding, modifying, or fabricating any factory or aftermarket product to your ATV/UTV may violate certain local, state, and federal laws. Be advised that laws vary depending on town, city, county, state, etc. Use of certain products on public streets, roads, or highways may be in violation law. The Buyer is solely and exclusively legally and personally responsible for any violation of the law by the installation or use of the product. You must abide by all local, state, and federal laws, including but not limited to vehicle safety, traffic laws, and ordinances. It is your responsibility to know the laws and how they apply to you.

The Buyer is responsible to fully understand the capability and limitations of his/her vehicle according to manufacturer specifications, warnings and instructions and agrees to hold SuperATV® harmless from any damage resulting from failure to adhere to such specifications, warnings and/ or instructions. The Buyer is also responsible to obey all applicable federal, state, and local laws and ordinances when operating his/her vehicle while using this product, and the Buyer agrees to hold SuperATV® harmless from any violation thereof.

- Install Foam around top of Frame. Foam to be flush with channel.



Install Brackets and Foam only if SuperATV Rear Windshield is installed.

- Remove and replace Brackets in Rear Windshield with Brackets included with Roof.
- Reuse hardware.



- Install Foam, against Gasket, to Rear Windshield.
- Follow Gasket as shown.

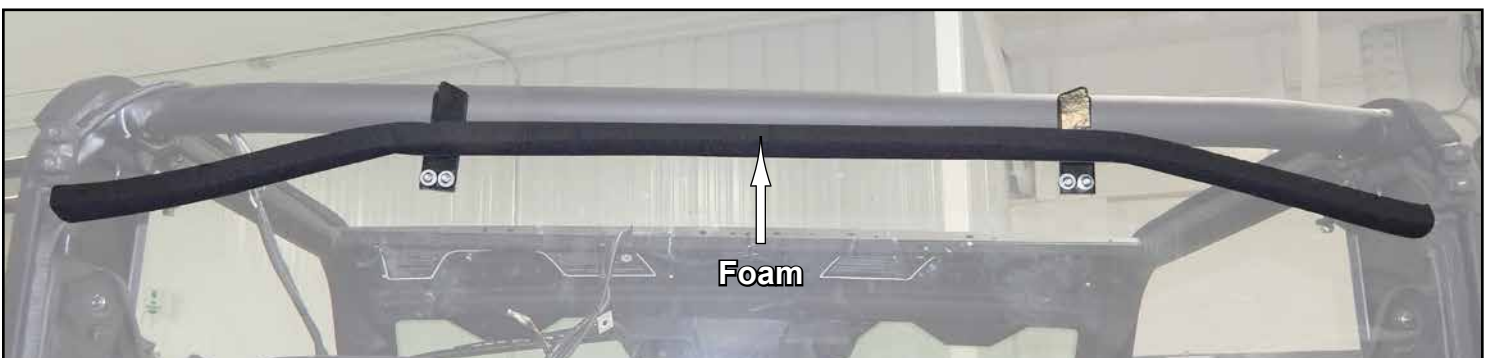

2 people are recommended to place Roof halves

- Place Rear Roof onto machine and install Seal to location shown.



- Place Front Roof onto Rear Roof and machine.





Rubber must face plastic when installing Sealing Washers

2 people are needed to tighten hardware.

- Secure Clamp/Bracket to Roof halves with hardware shown.
- Repeat for remaining (3) locations shown.

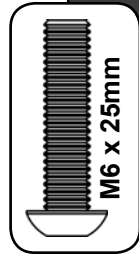

M6 x 25mm

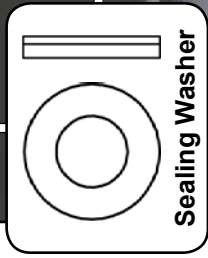

Sealing Washer



M6 Nut

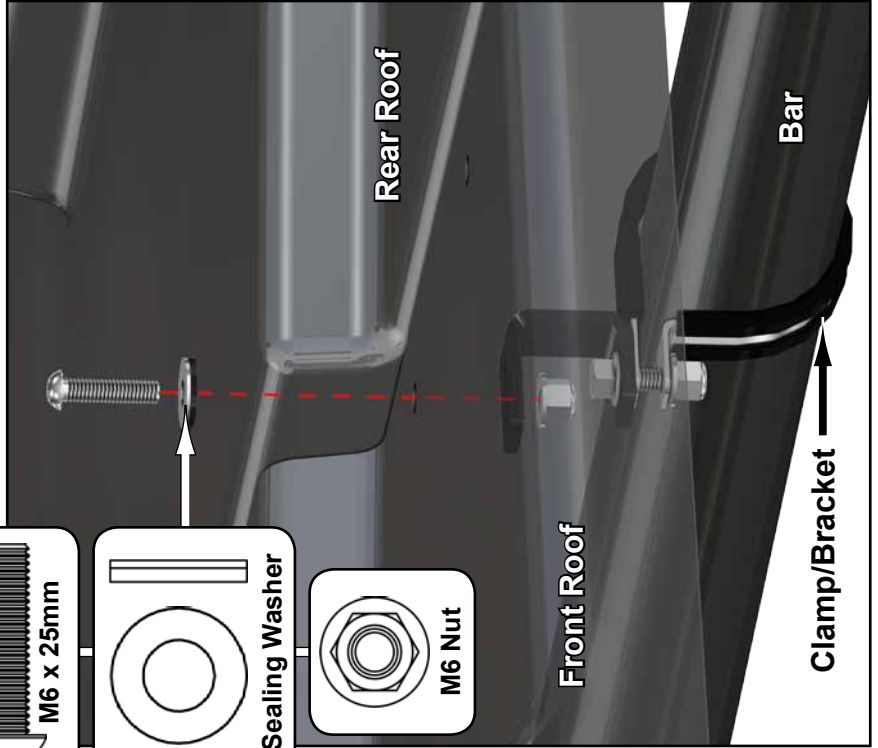

- Install Clamp around Bar and install Bracket to Clamp with hardware shown.

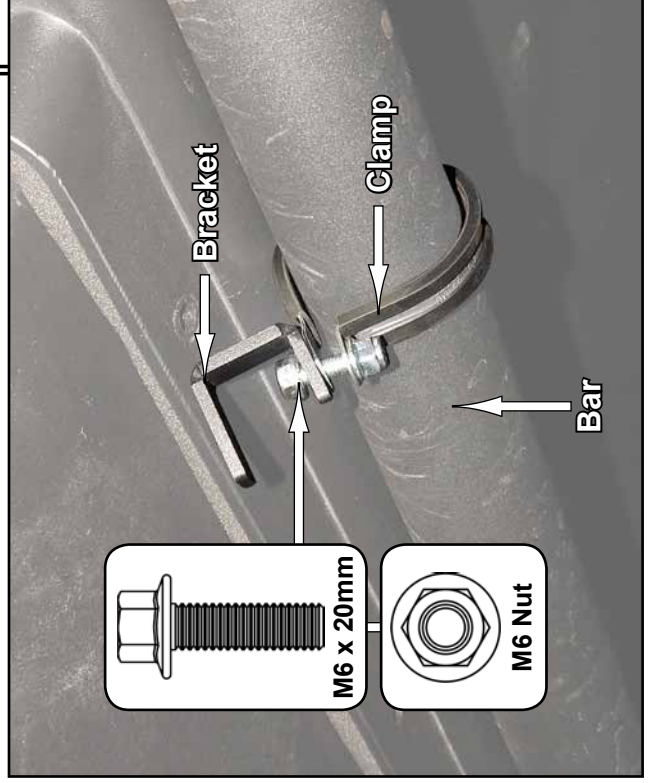

M6 x 20mm

M6 Nut

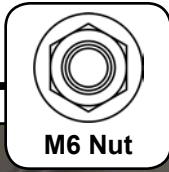
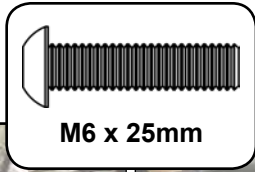

2 people are needed to tighten hardware.

- Join Roof halves with hardware shown.
- Repeat for remaining (2) locations shown.

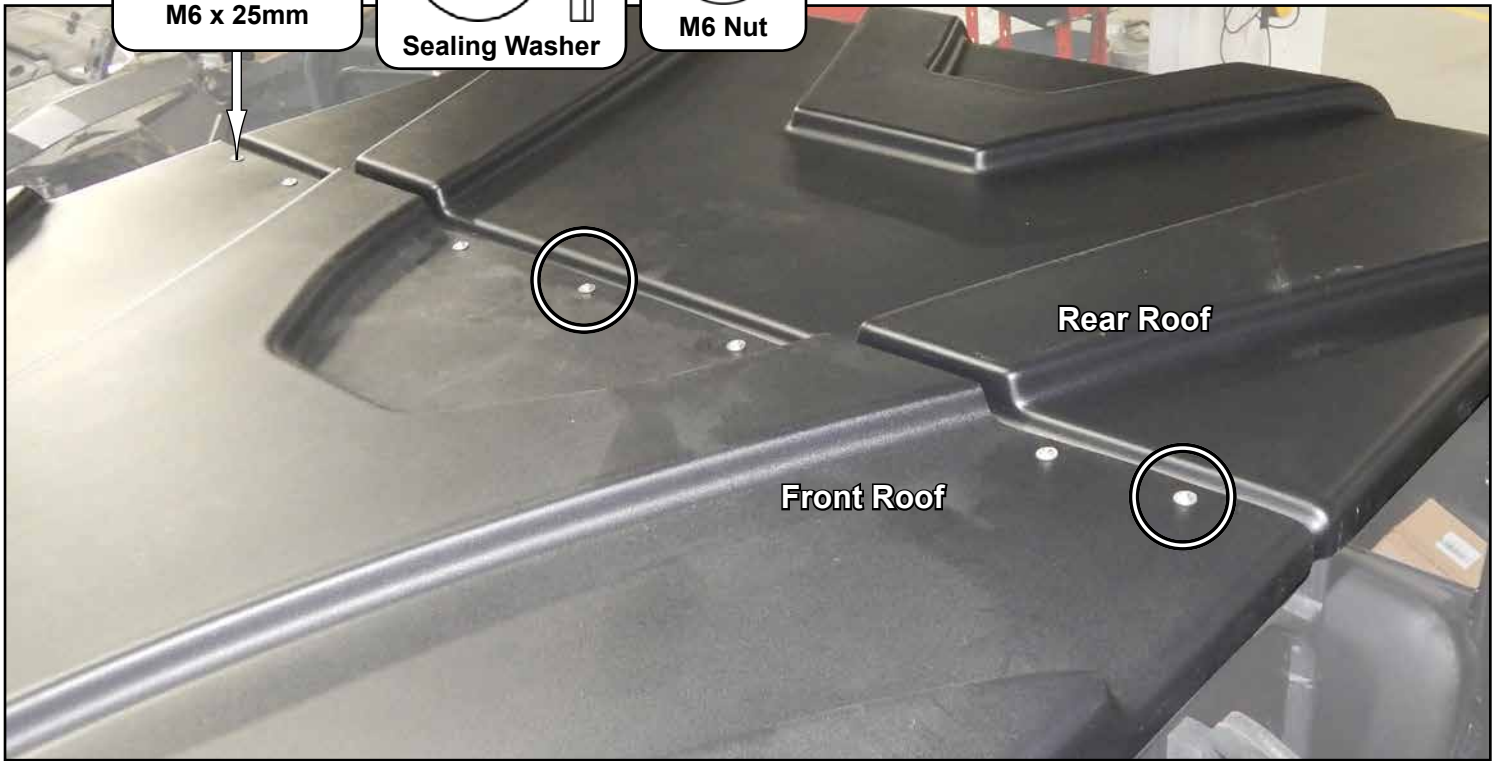

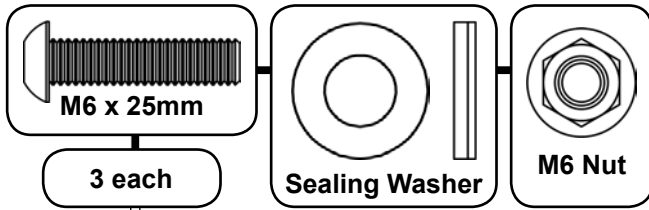

- Secure Front Roof to Frame with hardware shown.



- Secure Rear Roof to Frame with hardware shown.

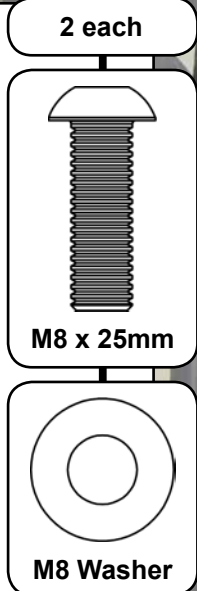

- Align Roof to machine and tighten all hardware completely.

- Use provided Cable Tie Mounts and Cable Ties to secure wiring to Roof if applicable.

